

600L ALT. AND P.S.

Small Block Chevy - Short Water Pump



Technical Information

This bracket system is designed for small block Chevilles, El Caminos and other front-steer applications where space is limited for power steering pump clearance. AS WITH ANY PART OF THIS NATURE, MAKE SURE IT FITS YOUR APPLICATION BEFORE PAINTING OR PLATING. PARTS THAT HAVE BEEN PAINTED, PLATED OR MODIFIED MAY NOT BE RETURNED.

- To insure proper function and installation of this product, please read the following detailed instruction (steps 1 - 4) following this information page.

- Be sure to start all bolts before tightening.

Header Information

- This bracket system is designed to work with exhaust manifolds and most headers. If using headers make sure you check for clearance at the front header tube by attaching a deep-well socket to the (front) first and third header flange fasteners. This represents the 2 $\frac{1}{4}$ " spacers that will be used to space the exhaust bracket off of the header tubes. If your front header tube interferes with the deep-well socket; your headers will not work. With the many different header designs, flange and gasket thicknesses; the use of headers may require slight modifications to the exhaust bracket and exhaust bracket spacers. See the diagram below for exhaust bracket modification.

-To check proper fitment of the exhaust bracket; follow Step 3 in this instruction manual and loosely install the 3 $\frac{1}{4}$ " bolt, exhaust bracket and 2 $\frac{1}{4}$ " spacer to the 3rd attachment point. If you can align the front mounting point of the exhaust bracket to the first attachment point of the header flange without contacting the front header tube; no modification is necessary. If Not; the exhaust bracket will need to be notched for clearance of the front header tube (See Diagram below).

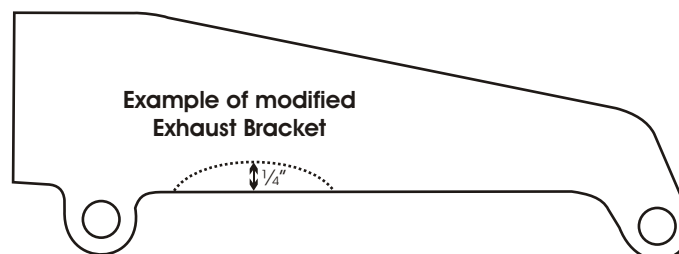

- To check proper fitment of the exhaust bracket spacers follow step 4, but before installation of alternator make sure the alternator mounting point of the exhaust bracket is fully aligned with the alternator mounting point of the front plate. If they are not fully aligned you must equally shorten the spacers until proper alignment is achieved. Without proper alignment the alternator will not be square with the front of the engine, and will cause belt miss-alignment.

Power Steering Information

Chevrolet first used the attached reservoir pump in 1961 and they are still in use today in a few applications. This bracket assembly is designed to work with the factory Chevelle and El Camino power steering pump as well as the more readily available late model pumps(see pump recommendation and applications below). If using the stock Chevelle or the power steering pumps recommended below; the stock high pressure hose can be used.

The following list of power steering pumps are just a few of the many available pumps that we have used with our power steering pump brackets. All reservoirs **MUST HAVE THE TWO ATTACHMENT POINTS ON THE BACK OF THE RESERVOIR AS SHOWN, AND THE CORRECT PLACEMENT OF THE RETURN LINE THAT WILL WORK WITH THE APPLICATION.**

- A two groove V-8 Chevrolet power steering pump pulley must also be used for correct belt alignment.

POWER STEERING PUMP PULLEYS

CHEVROLET PART NUMBER

Two groove bolt-on pulley----- 3941107

Two groove press-fit pulley----- 14084343

- If your power steering pump has a 3/8" stud; you may use it at the upper attachment point; if not; Please use the provided hardware in our bracket kit for proper installation (see the rear view of pump diagram below).

Rear View of Pump

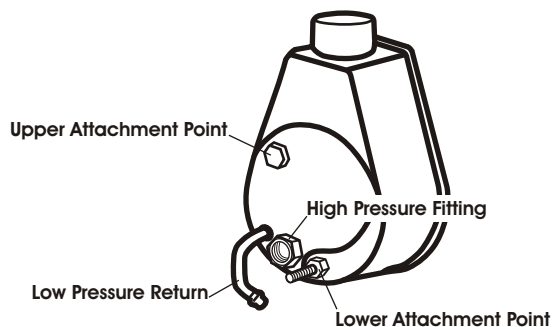

Pulley Dimension

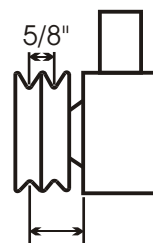

V-8 power steering pump pulleys measure 1 13/16" center of pulley to face of pump.

Pump Applications

6000 SAGINAW PUMP

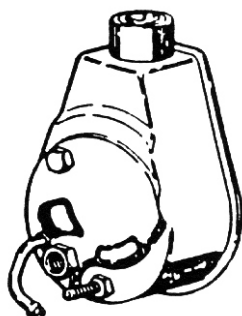

5/8" keyed shaft for
nut retained pulley

inverted flare fitting

Applications pumps are found on:

70-74 Camaro 8 cylinder
71-74 Chevelle, Malibu 8 cylinder

6012 SAGINAW PUMP

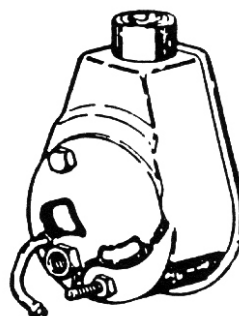

3/4" smooth shaft
for press-fit pulley

inverted flare fitting

Applications pumps are found on:

75-78 Camaro 8 cylinder
75-77 Malibu 8 cylinder

Belt Information

We use a belt length of 56 - 57" for the alternator mount and a 41 - 42" belt for the power steering mount in our shop. However; this can vary with the diameter of your pulleys.

- **Note:** to provide clearance for the alternator belt and power steering box; this bracket system will require a different belt routing than what the stock belt routings were. Please follow the belt routing diagrams below.

- **Be sure and tighten the power steering pump belt first before tightening the alternator belt.**

Belt Routings Without A.C.

To Alternator and (Inner) Power Steering

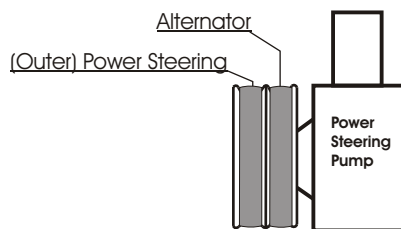
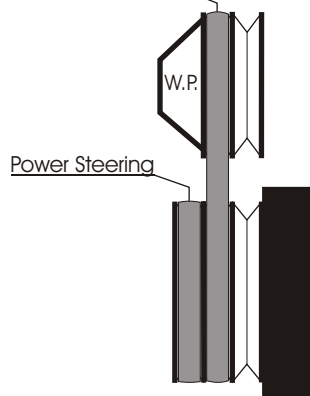

Belt Routings With A.C.

(Inner) A.C. Compressor

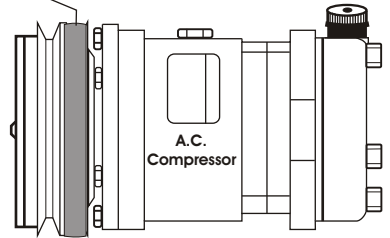

To Alternator and (Inner) Power Steering

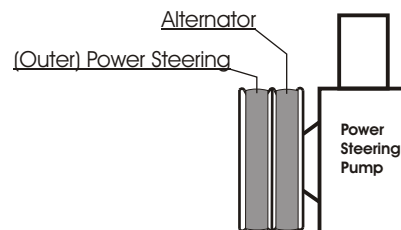
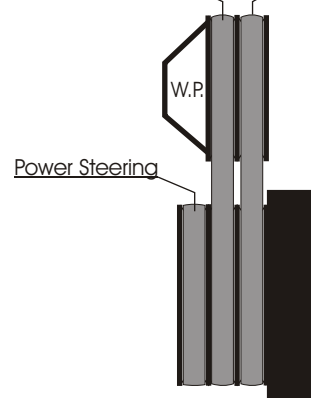

Step 1:

Note: Assemble both front and rear bracket plates to power steering pump first before attaching to engine block.

Note: See power steering pump information page for pump installation notes and diagrams.

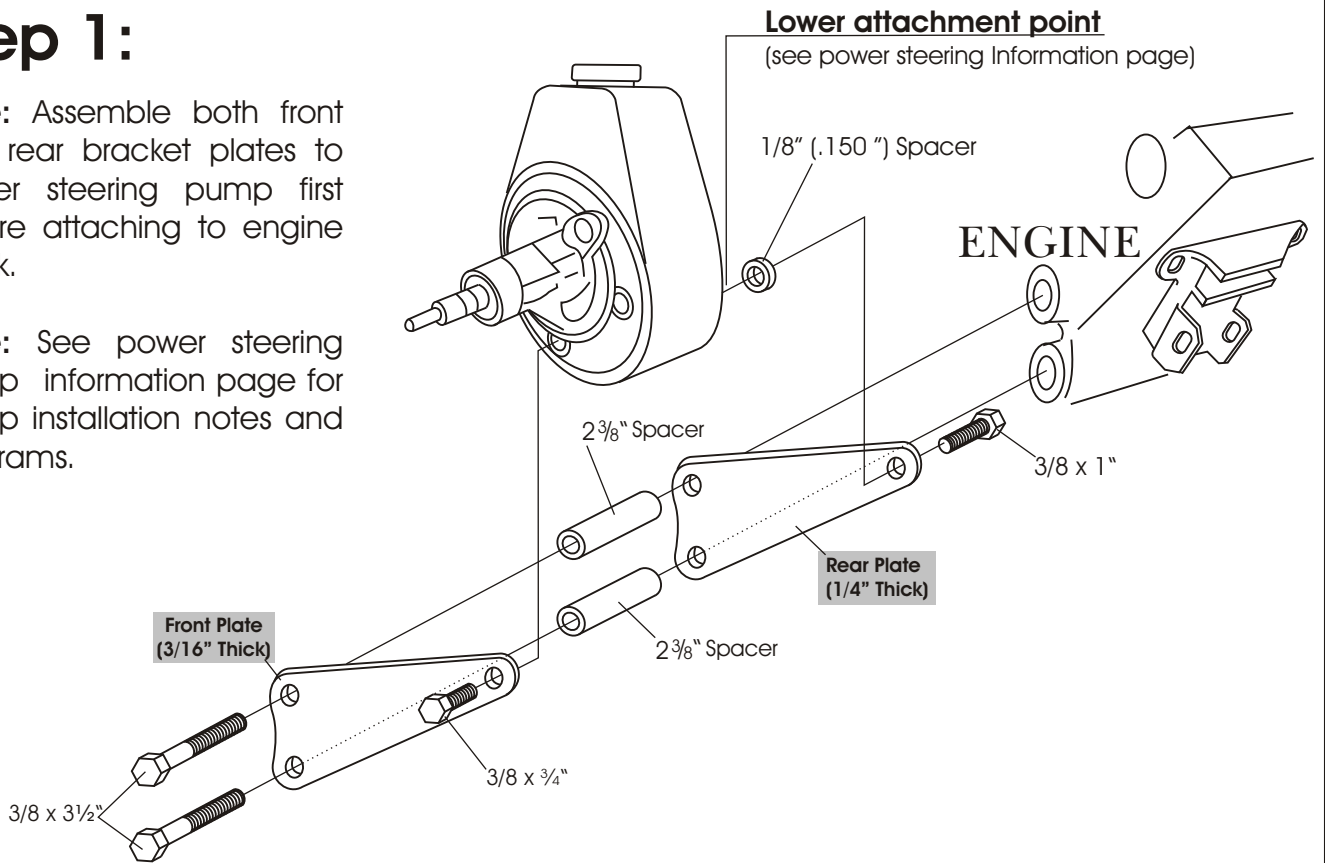

Step 2:

Power Steering Pump With Stud

-Attach exhaust bracket to upper rear attachment point of the power steering pump. Some pumps are equipped with a 3/8 stud in the back; determine which installation best suits your pump application. **See the Power Steering Information page for further installation notes.**

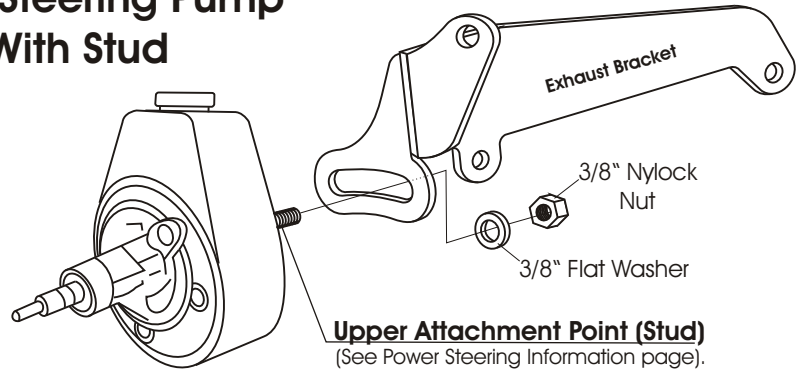

Power Steering Pump Without Stud

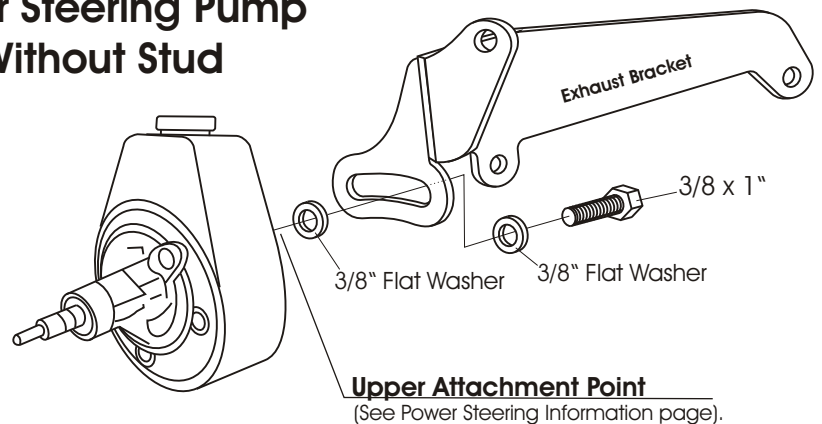

Step 3:

- Remove (Front) First and Third exhaust bolts from exhaust manifolds or Header Flange.

***NOTE: Exhaust Spacers**

-**HEADERS** - use the 2 1/4" long x 5/8" O.D. Spacers.

-**CHEVELLE DROP-TYPE MANIFOLDS** use the 1 1/16" long x 3/4" O.D. Spacers at both bracket holes.

-**RAMS HORN MANIFOLDS** use the 1/4" long x 3/4" O.D. Spacer at rear hole of bracket and a 1 1/16" long x 3/4" O.D. spacer at front hole of bracket.

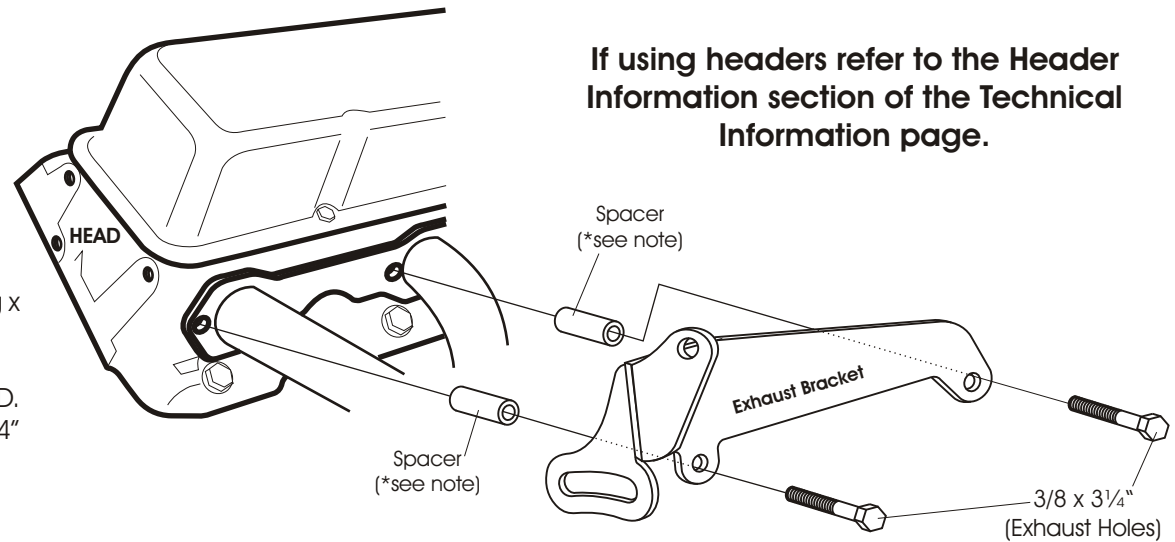

Step 4:

- Install Idler bracket and front plate to water pump first.

- Attach Alternator Adjuster to top Alternator mounting point.

- Install alternator to front plate and exhaust bracket.

- Install Idler Pulley Last.

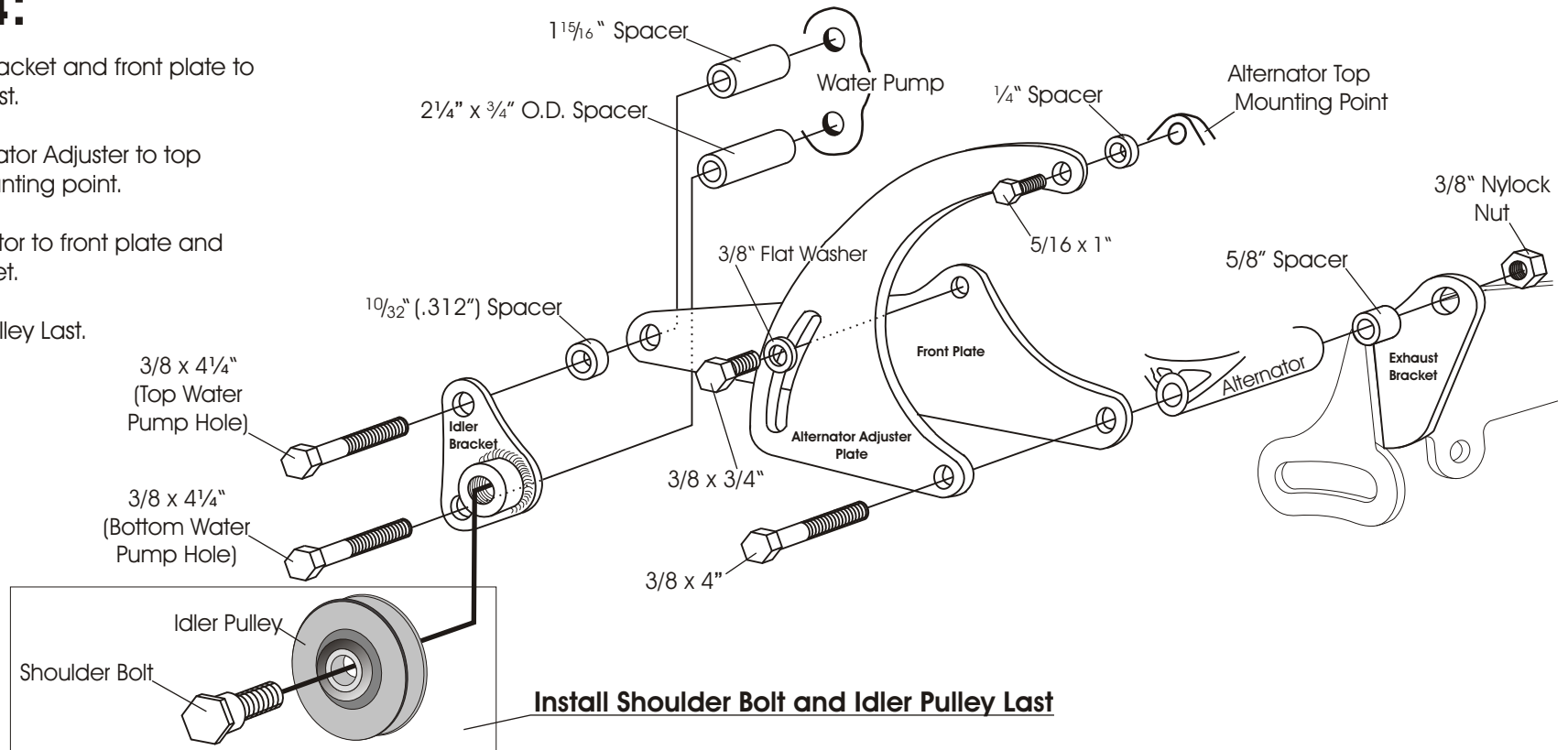

ALTERNATOR &
POWER STEERING
MOUNT

600L

Small Block Chevy - Short Water Pump
Driver Side

ALAN GROVE COMPONENTS, INC.
27070 METCALF ROAD
LOUISBURG, KS 66053